



EMC

ELEVATE YOUR FINISHING TOUCH

ROTOFLEX LINE

M650 - M1350 - M1650

EDGE
Rounding
solution



www.emcmachines.com



EMC Italia srl

JOUSTAVA KOKOONPANO, SINÄ PÄÄTÄT!

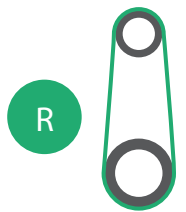
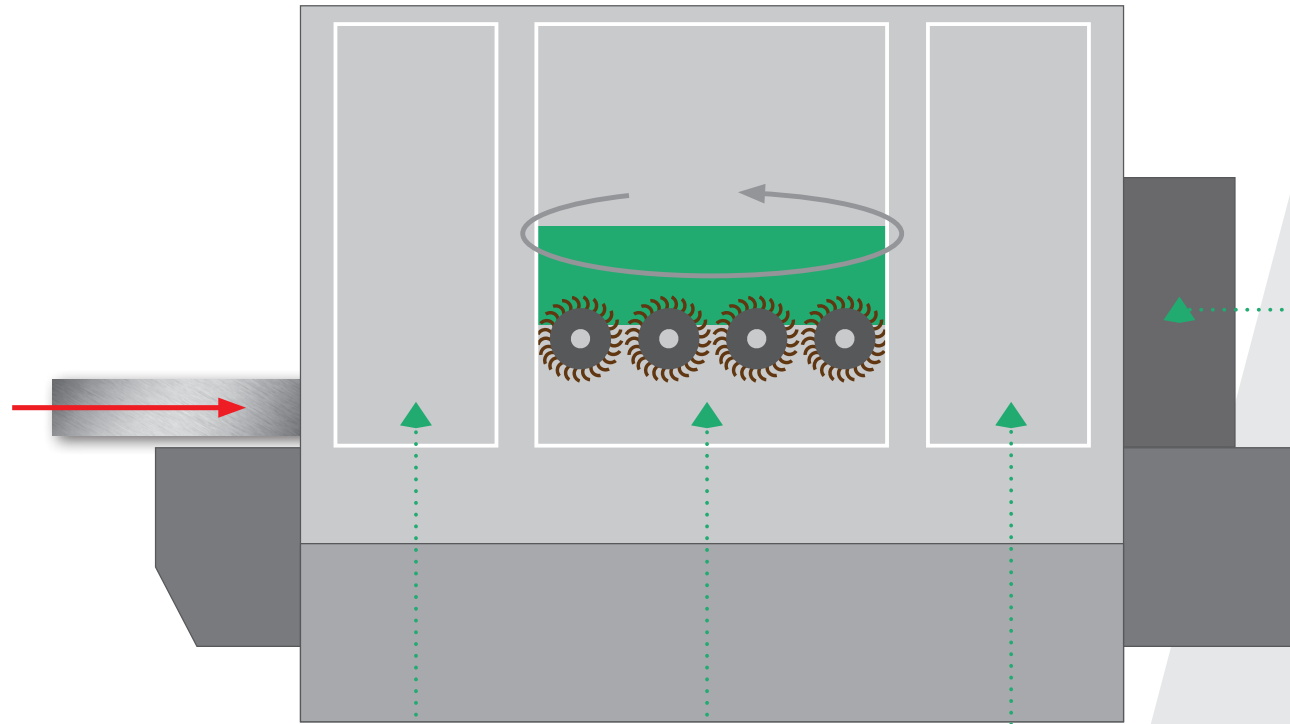

Gruppo operatore Rullo
Working unit roller
Hiomanauhaysikkö



Gruppo spazzole tangenziali 1x
Tangential brushes unit 1x
Pyörivä harjaysikkö 1x

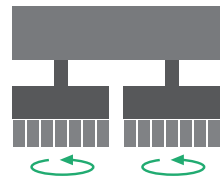

Gruppo spazzole tangenziali 2x
Tangential brushes unit 2x
Karuselliharjaysikkö 2x

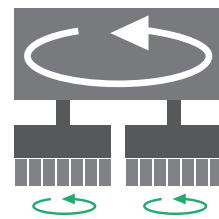

Sistema planetario
Planetary system
Karusellijärjestelmä

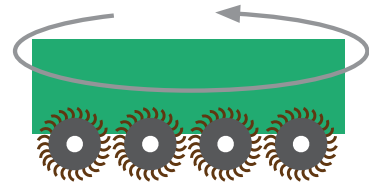

Sistema di lavoro planetario con 12 spazzole rotanti
Planetary working system by 12 brushes
Karusellijärjestelmä 12 harjaa



Gruppo spazzola Ø200
Brushing unit Ø200
Harjaysykkö Ø200



Gruppo spazzola Ø150
Brushing unit Ø150
Harjaysykkö Ø150



Turbo-soffiatori
Turbo rotating blowers
Pyörivät turbopuhallitimet



Soffiatore compatto
Compact blower
Kompakti puhallin

12B

Sistema di lavoro planetario con 12 spazzole rotanti

Planetary working system by 12 brushes

Karuselli työstöjärjestelmä 12 harjaa

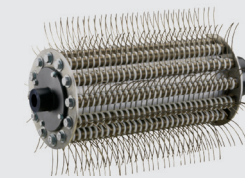
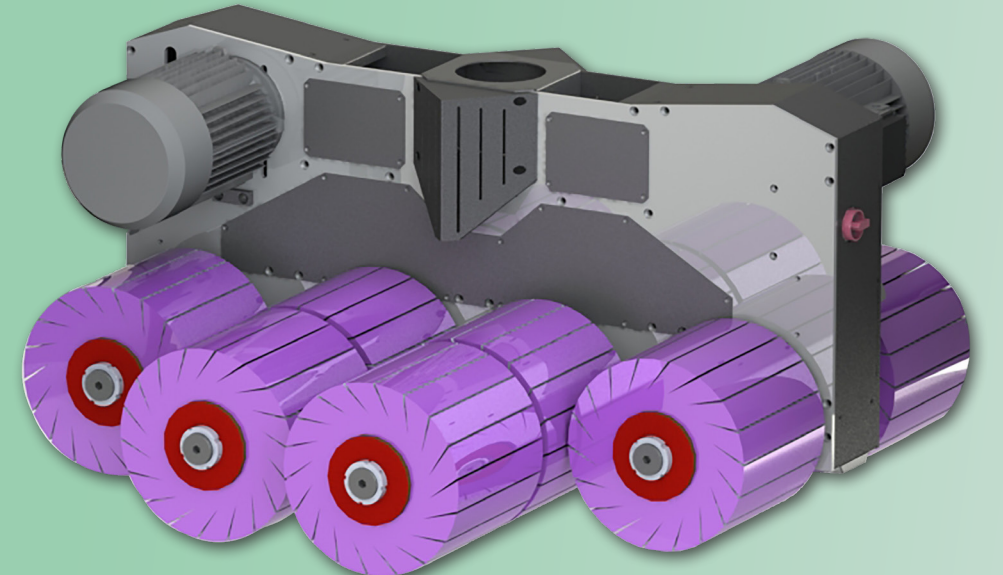

Gruppo spazzola longitudinale
Longitudinal brush unit
Harjaysykkö

Ø250

Ø330



Gruppo spazzole tangenziali / sistema planetario

Tangential brushes unit / planetary system

Pyörivä harjaysykkö / karusellijärjestelmä

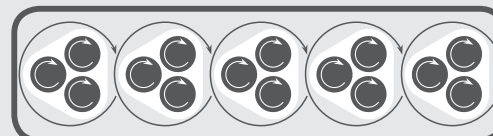
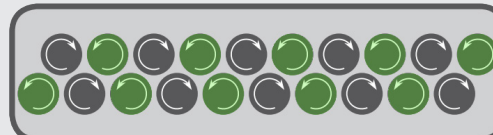

Gruppo operatore Rullo
Working unit roller
Hiomanauhaysikkö



Dimensione nastri abrasivi (sviluppo) 2620-3250mm
Abrasive belt (length) 2620-3250mm
Hiomanauha (pituus) 2620-3250 mm

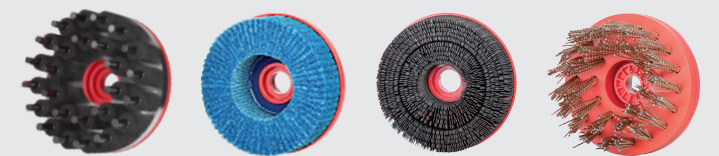

Spazzole tangenziali con cambio rapido
Tangential brushes with quick change device
Nopeasti vaihdettavat pyörivät laikat

ROTOFLEX LINE

M650 - M1350 - M1650

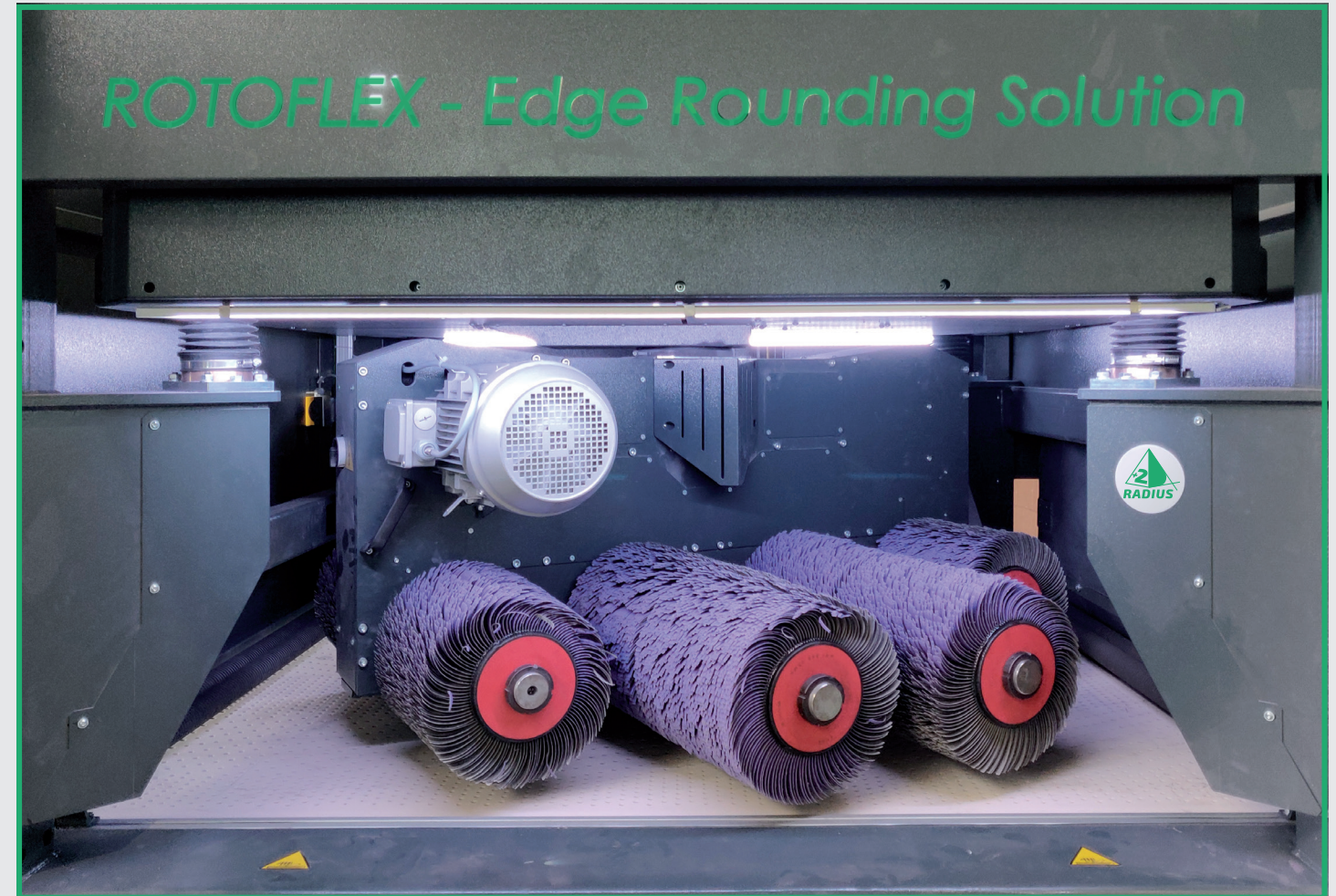

EDGE
Rounding
solution



MAKE YOUR CONFIGURATION

R2

PLASMA

LASER

KAIKKI

VALITSE OMA KOKOONPANOSI

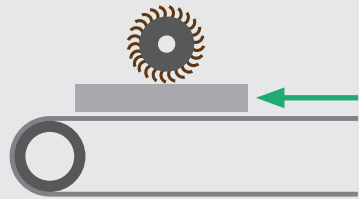

Spazzola pulizia pezzi
Brush for panels leaning
Harja paneelien puhdistamiseen

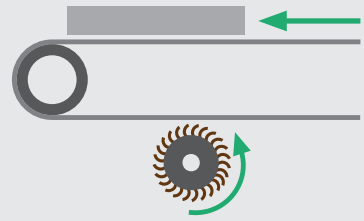

Spazzola pulizia tappeto
Brush for feed belt cleaning
Harja kuljetinhihnan puhdistamiseen

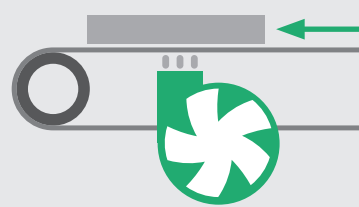

Depressore interno (taratura variabile, inverter)
Internal vacuum fan (setting variable, inverter)
Imupöytä, puhallin integroitu koneen jalustaan (säädettävissä portaattomasti, invertteri)

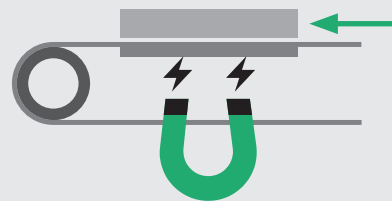

Pista magnetica
Magnetic band
Magneettinen nauha



Rulliere di estensione
Rollers table extension
Jatkopöytä rullilla

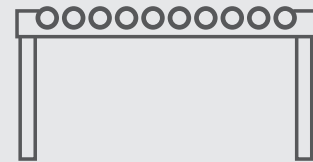

Tavolo di estensione
Extension table
Jatkopöytä



Soffiatore compatto
Compact belts blower
Gebläse für Puhallin hiomahihnan puhdistusta varten



Turbo-soffiatori
Turbo rotating blowers
Pyörivät turbopuhaltimet

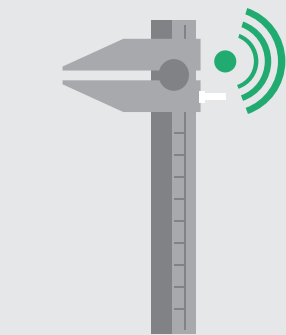

Posizionatore automatico
Automatic positioner
Automaattinen paikoitus



Touch screen 15"
Touch screen 15"
15" kosketusnäyttö

R2

Soluzioni per ogni raggatura
Edge rounding solution
Reunan pyöristys

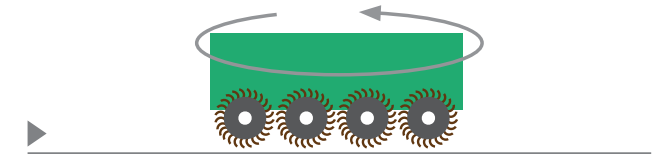

12B



PLASMA

Rimozione scorie e raggatura spigolo
Deslagging and edge rounding
Kuonanpoisto ja reunan pyöristys

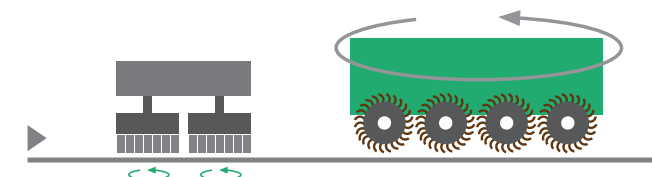

H

12B



LASER

Sbavatura e raggatura spigolo
Deburring and edge rounding
Purseenpoisto ja reunan pyöristys

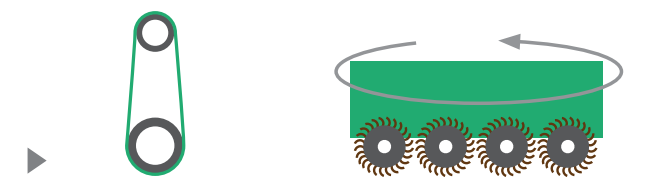

R

12B



KAIKKI

Sbavatura, raggatura spigolo e finitura
Deburring, edgerounding and finishing
Purseenpoisto, reunan pyöristys ja viimeistely

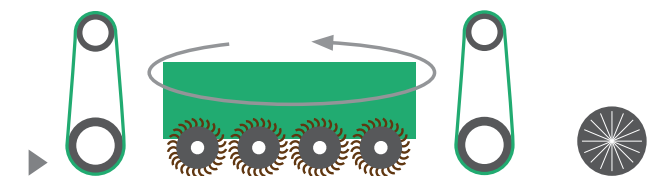

R

12B

R

b



Energiansäästö



Lisätty todellisuus

INDUSTRY 4.0 READY

ROTOFLEX LINE

M650 - M1350 - M1650

MACCHINA BASE
BASIC MACHINE
STANDARDMASCHINE

Versione a 1/2/3 operatori

Version 1/2/3 operators
1/2/3 työvaiheen kone

Altezza fissa 900mm

Fixed height 900mm
Kiinteä korkeus 900 mm

Larghezza utile di lavoro 650-1350-1650mm

Working width 650-1350-1650mm
Työleveys 650-1350-1650mm

Spessore di lavoro min/max 0.5-170/200mm

Working thickness min/max 0.5-170/200mm
Työn paksuus min/max 0.5-170/200mm

Dimensione nastri abrasivi (sviluppo) 2620mm

Abrasive belt (length) 2620mm
Hiontahihna (pituus) 2620mm

Inverter controllo velocità avanzamento

Inverter for feed speed control
Inverteri nopeudensäätöä varten

»» TARVITSETKO APUA?

EI HÄTÄÄ. KYTKE VAIN ANTAMAMME
KAAPELI KONEESEEN.

EMC TEKNIKKO TEKEE LOPUT.

CONTACT US service@emc-italia.it



LAYOUT DEDICATO
DEDICATED LAYOUT
RAKENNE

ALIKO
Press brakes from Finland

Aliko Oy Ltd

Yrittäjänkulma 5,
33710 Tampere, Finland

Tel. +358207 280 370

EMC®

ELEVATE YOUR FINISHING TOUCH

EMC s.r.l. Headquarters

Via Brodolini 23
40026 Imola (BO), Italy

EMC s.r.l. Plant 2

Via Altobelli 8/A
40026 Imola (BO), Italy

Find out more at:

Informazioni immediate al numero:

Tel. +39 0542 6880 34
info@emcmachines.com

www.emcmachines.com

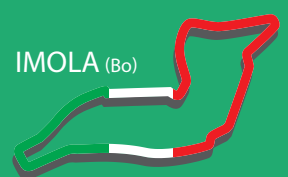

MADE in ITALY



EMC Italia srl